

ENERFREES STOREFRONT FRAME

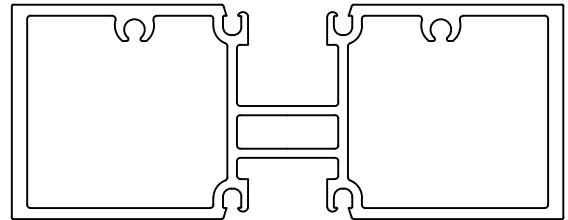
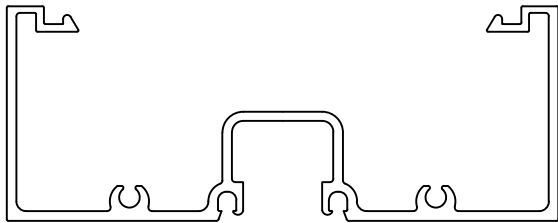

DESCRIPTION:

NON-THERMAL FLUSHGLAZE UNIT. 1 3/4" STOREFRONT

GLAZING:

SERIES 4200 ACCEPTS 1" DOUBLE GLAZE, AND 12MM SINGLE GLAZED (Adapter to be added on single glazing).

STOCK LENGTH:



18'
24" AVAILABLE UPON REQUEST

STANDARD FINISHES:

STOCKED:
CLEAR ANODIZED
MILL FINISH
BLACK POWDER COAT



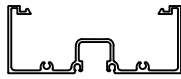
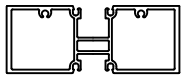
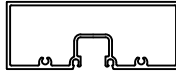
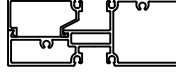

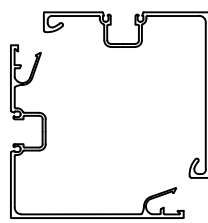
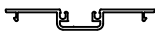

NON-STOCKED:
BLACK ANODIZED

ENERFREES STOREFRONT FRAME

PART #	PART	DESCRIPTION
430001		2 " X 4 1/2" Open Perimeter Stock Length
430002		2 " X 4 1/2" Vertical Mullion Stock Length
430003		2 " X 4 1/2" Enhanced Vertical Mullion Stock Length
430004		2 " X 4 1/2" Horizontal Mullion/ Sill Stock Length
430005		2 " X 4 1/2" Sill Back Stock Length
430006		4 1/2" X 4 1/2" Male half Corner Mullion Stock Length
430007		4 1/2" X 4 1/2" Female half Corner Mullion Stock Length
430008		2 " X 4 1/2" Mullion/ Sill Close Cap Used with Part# 430004 Stock Length



ENERFREES STOREFRONT FRAME

PART #	PART	DESCRIPTION
420201		Shear Block Sold per piece
430202		Shear Block Used with Part# 430004 Sold per piece
HF401		Thermal Door filler Used with Part# 430004 Stock Length
9303		1 1/2" X 1/2" Door Stop Base Stock Length
9304		1 1/2" X 1/2" Door Stop Cap Stock Length
R012		Interior Gasket Sold per roll (500')
420105		Door Adaptor



ENERFREES STOREFRONT FRAME

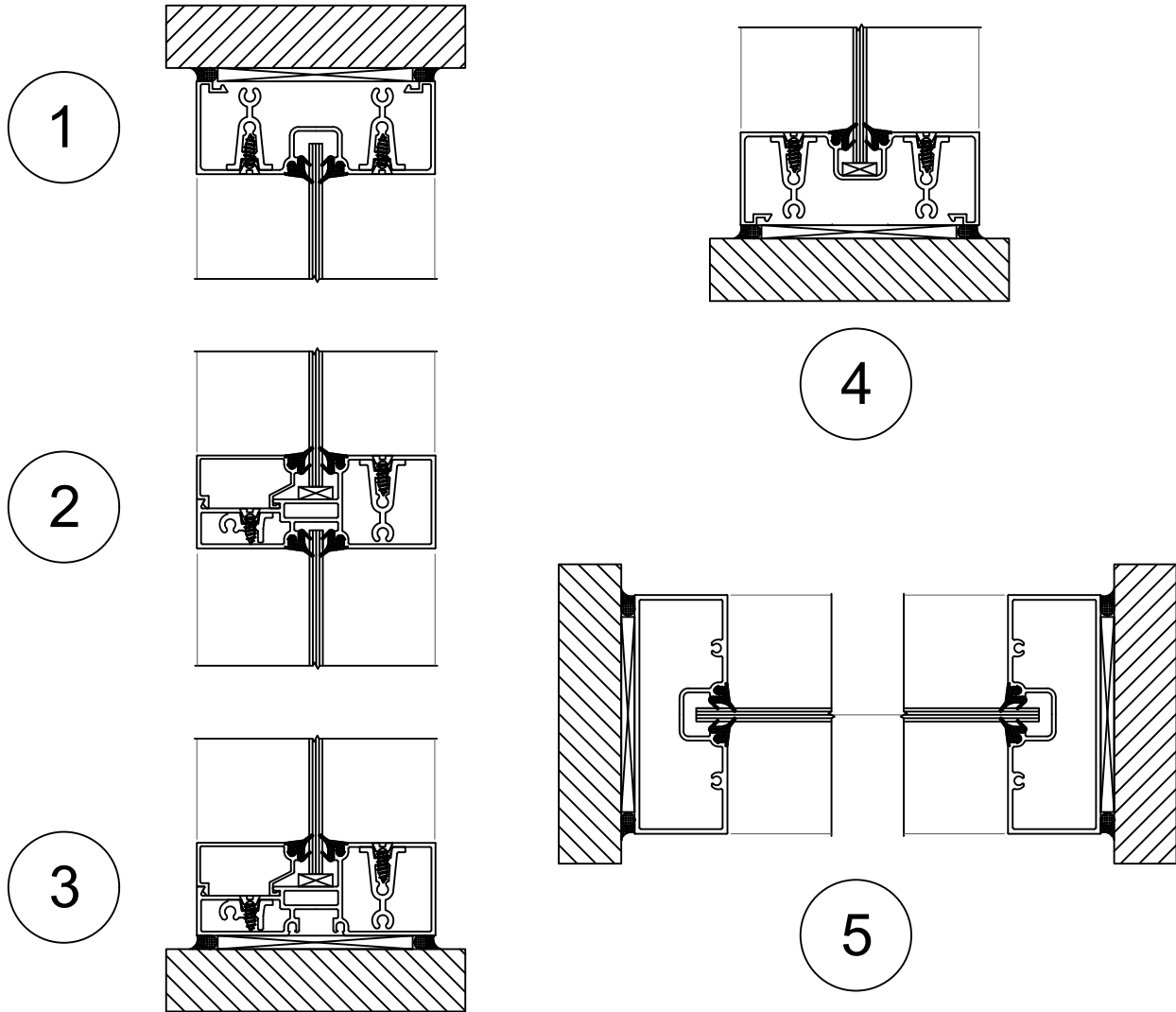

ENERFREES STOREFRONT FRAME

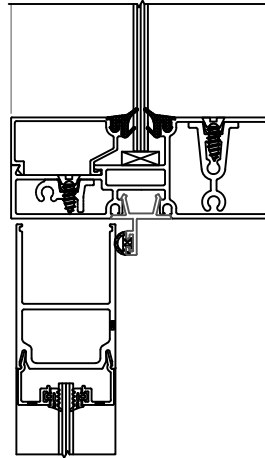

①
Top Rail

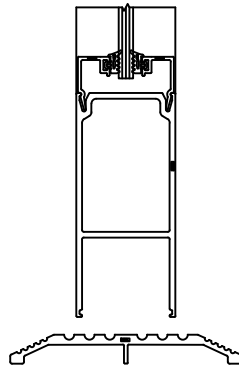

②
Bottom Rail

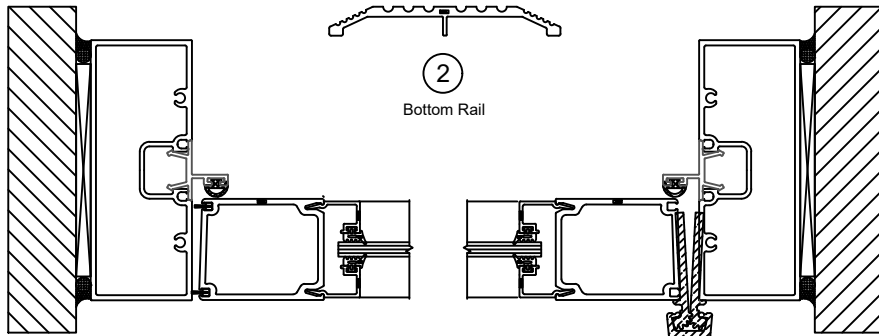

③
Stile

④
Continuous Hinge

