



HIGH PERFORMANCE THERMAL AWNING WINDOW  
EAW-1071



**FRAME**

FRAME DEPTH 70mm (2 ¾")

MAX SINGLE WINDOW WIDTH 1600mm (63')

MAX SINGLE WINDOW HEIGHT 1980mm (78')

**GLAZING**

Insulated, Tempered Glass, Low-E, Argon Filled, Warm-Edge Spacer, 3A Molecular Sieve

Thickness	Double Glazing	5mm+12mm+5mm (OVERALL = 22mm (7/8"))
		6mm+12mm+6mm (OVERALL = 24mm (1"))
		8mm+12mm+8mm (OVERALL = 28mm (1-1/8"))
	Triple Glazing	5mm+12mm+5mm+12mm+5mm (OVERALL = 39mm (1-1/2"))
		6mm+12mm+6mm+9mm+6mm (OVERALL = 39mm (1-1/2"))
		6mm+12mm+6mm+12mm+6mm (OVERALL = 42mm (1-5/8"))

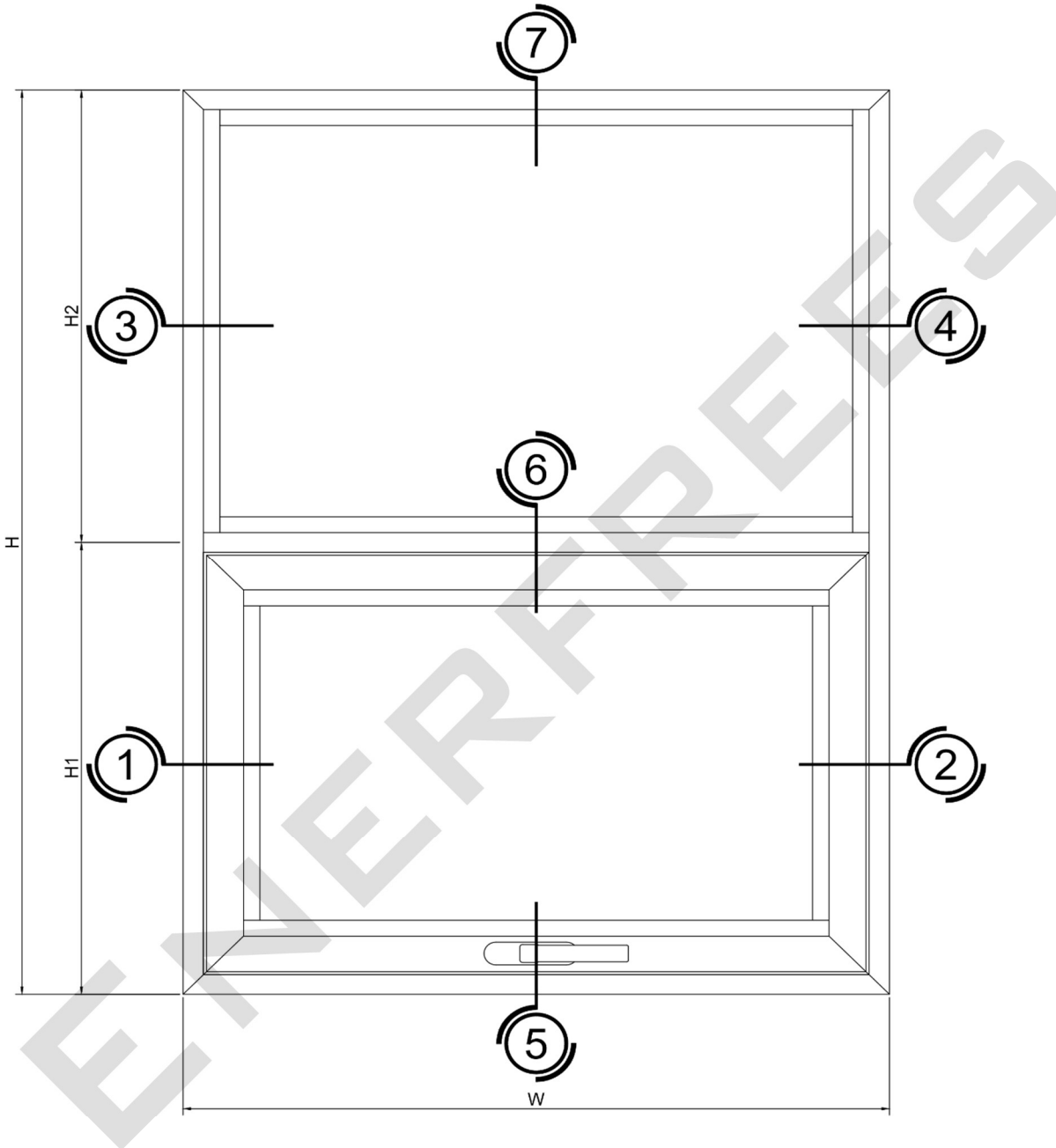



DETAILS:

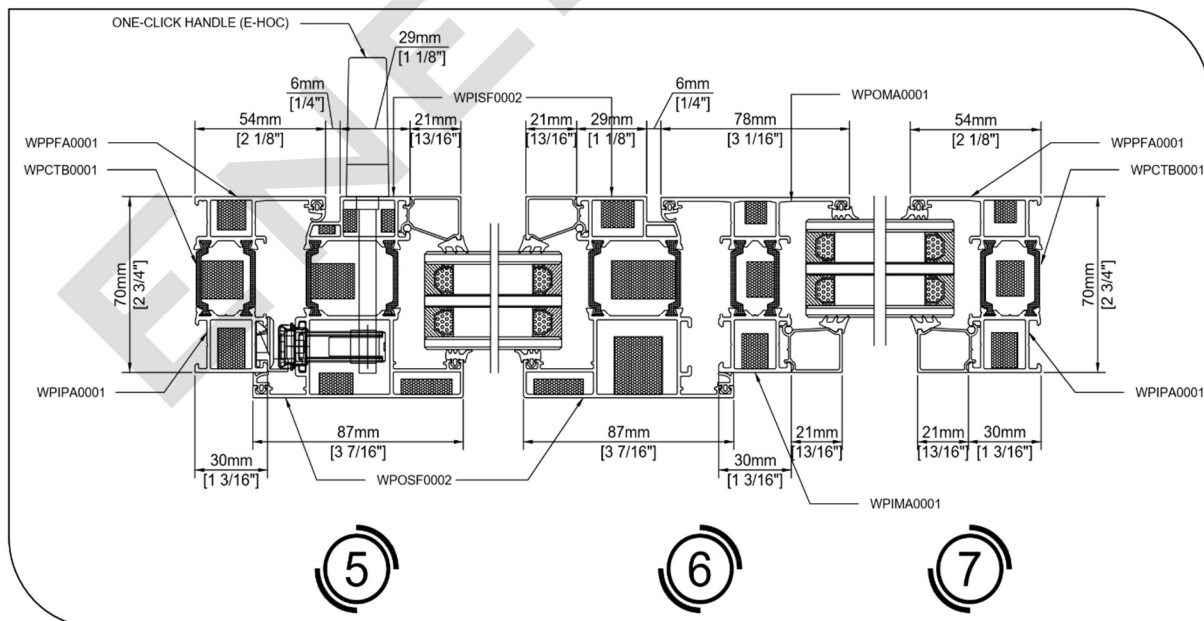
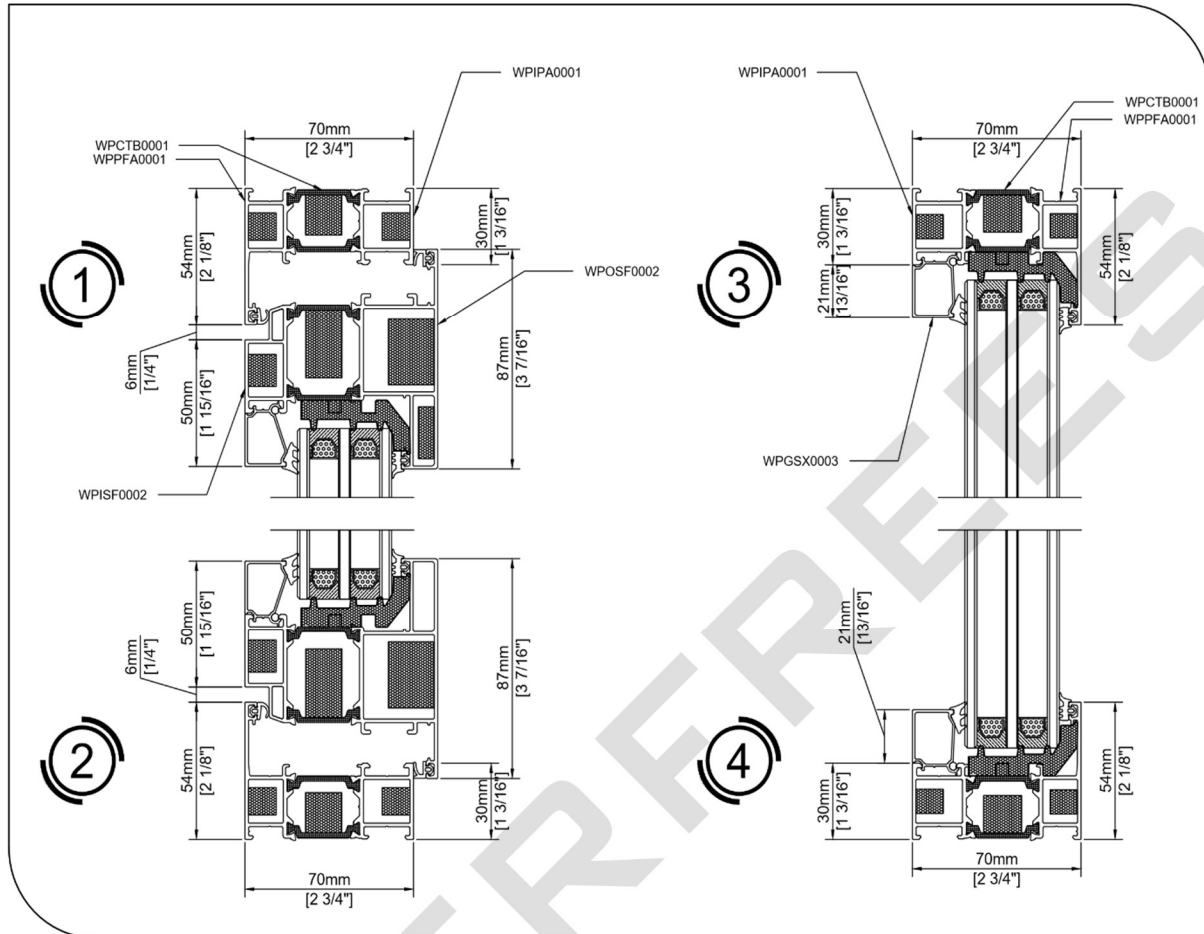

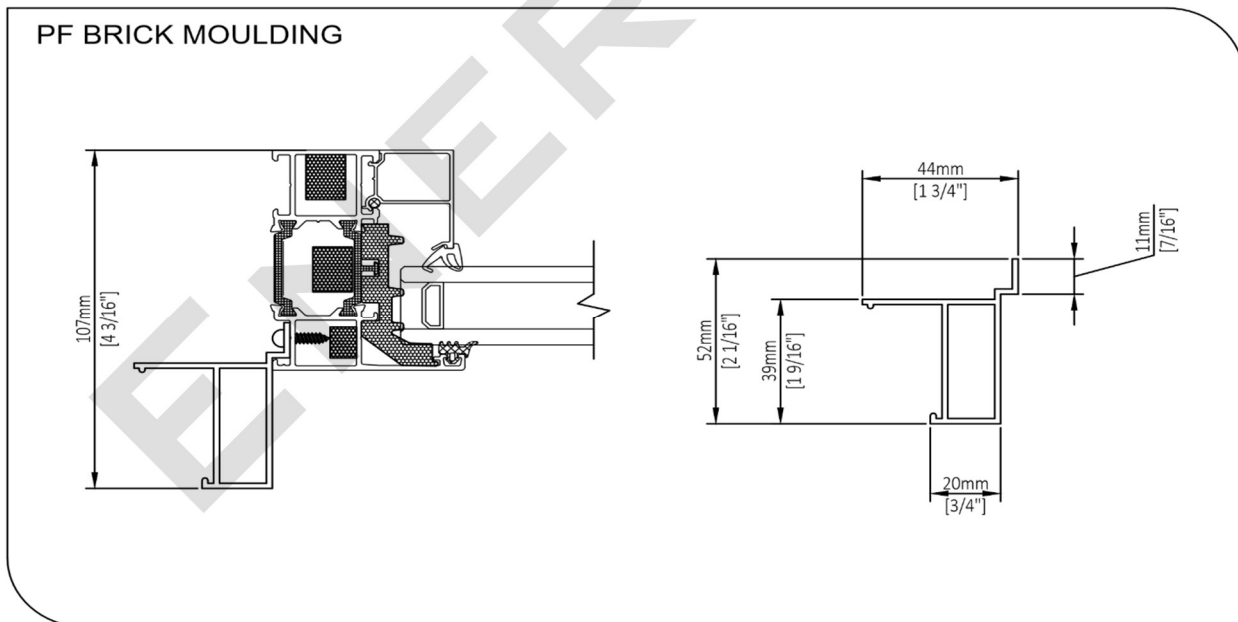
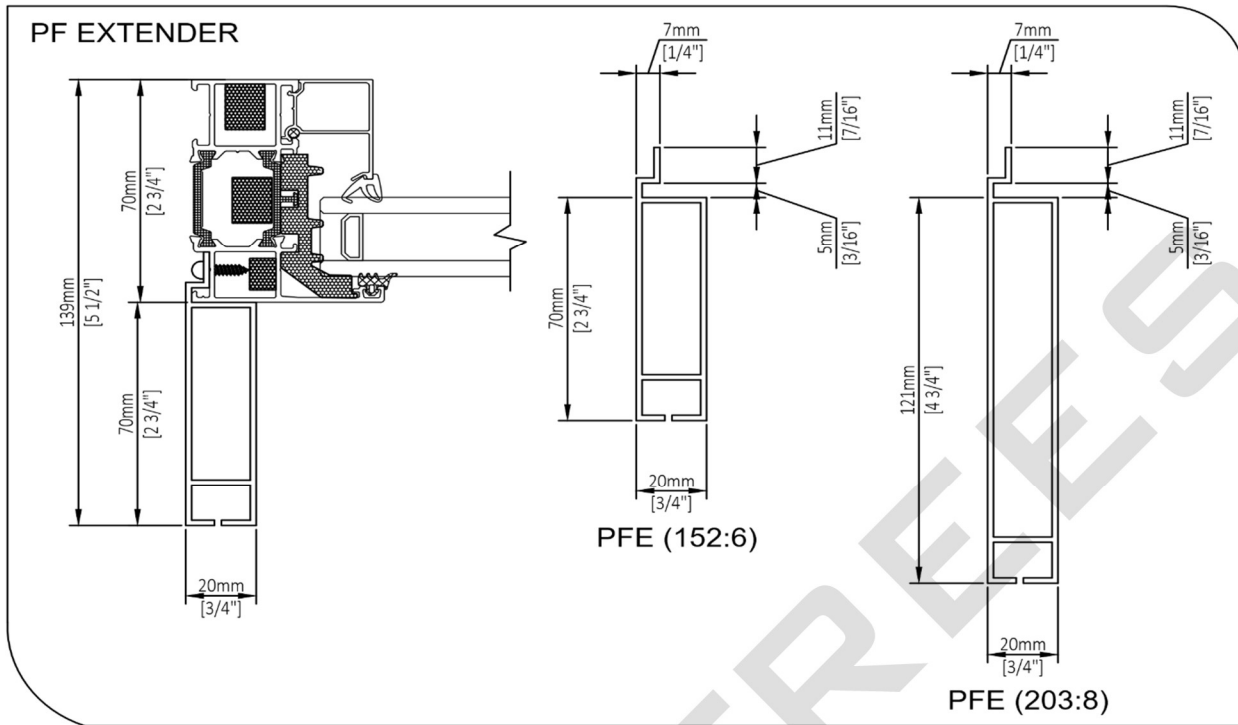

FENESTRATION



Commonly used in high-rise and mid-rise buildings to meet increased loading requirements and limits on deflection, and in buildings where frequent and extreme use of the fenestration products is expected.

### FINISH

POWDER COATED. Powder coating is a polyester based coating that uses uniformly sized micro-beads of polyester, electrostatically charged to adhere to base materials. The coating is thick like an epoxy paint, but because it is electrostatically charged and then baked/cured onto the base material, it doesn't flake or peel like paint or epoxy. The color is softer than comparable colors and the depth of the coating is larger.

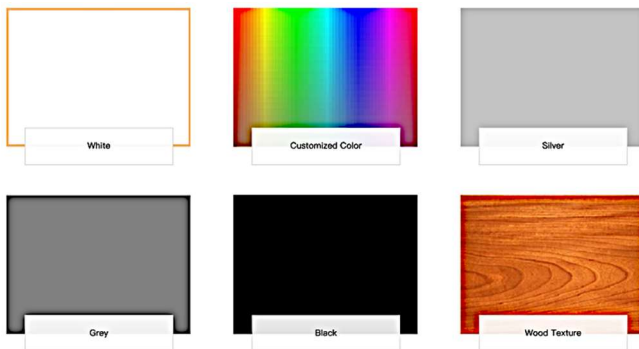

### ADVANTAGE:

- Wide selection of colours
- Texturized finish is an option

### ENERFREES HIGH-PERFORMANCE THERMAL BREAK (PA 66 OR NYLON 66)

Polyamide 66 (PA66) is a type of nylon. PA 66 is made of two monomers each containing 6 carbon atoms, hexamethylenediamine and adipic acid.

Melting point:	268.8 °C
Formula:	(C <sub>12</sub> H <sub>22</sub> N <sub>2</sub> O <sub>2</sub> ) <sub>n</sub>
Density:	1.31 g/cm <sup>3</sup>
Boiling point:	452.1 °C
PubChem CID:	3032893

### General Characteristic:

- High strength and stiffness at high temperature
- Good impact strength, even at low temperature
- Good abrasion and wear resistance
- Good fatigue resistance
- High water absorption and water equilibrium content limits the usage
- Low dimensional stability



**ENERFREES**  
Window & Wall Systems

## AWNING WINDOW

## S-EF1070

### FRAME DESCRIPTION:

High Performance Thermally broken window system with frame depth of 70mm (2 ¾") frame section.

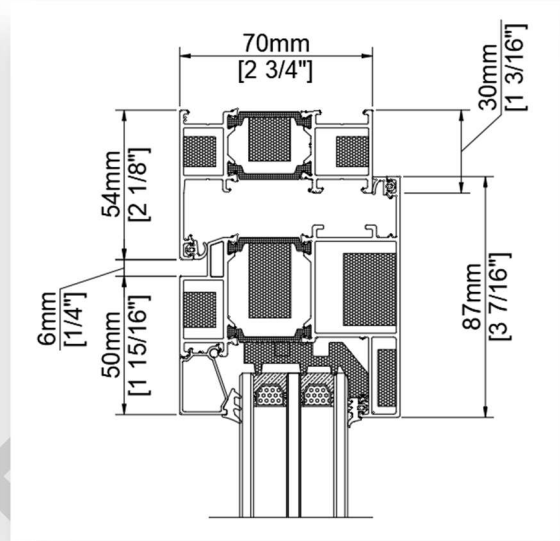
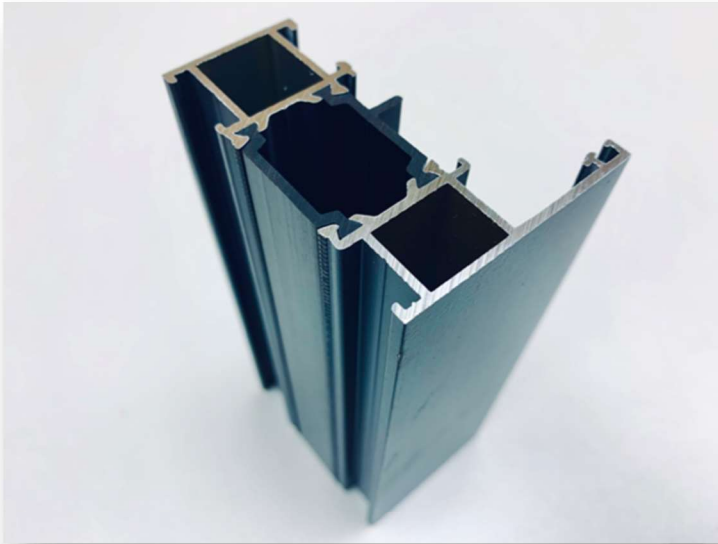

### PARTS AND ACCESSORIES (EF1070):

WPPFA0001 – PRIME FRAME ASSEMBLY (PFA)

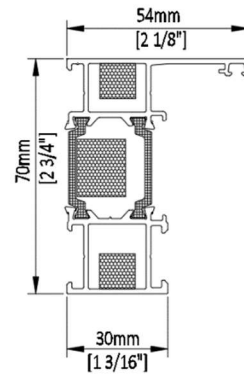

WPOPA0001 – OUTSIDE PRIME ALUMINUM (OPA)  
6063-T5

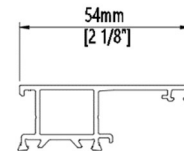



WPCTB0001 – C THERMAL BREAK (CTB)  
NYLON 66 (PA66)

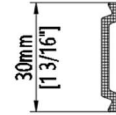

WPYTB0001 – Y THERMAL BREAK (YTB)  
NYLON 66 (PA66)

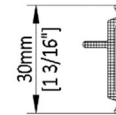

WPIPA0001 – INSIDE PRIME ALUMINUM (IPA)  
6063-T5

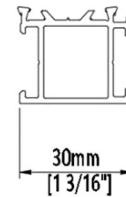

WPMFA0001 – MULLION FRAME ASSEMBLY (MFA)

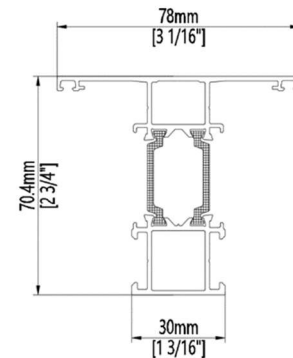

WPOMA0001 – OUTSIDE MULLION ALUMINUM (OMA)  
6063-T5

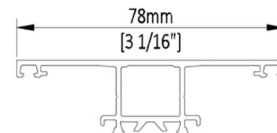

WPIMA0001 – INSIDE MULLION ALUMINUM (IMA)  
6063-T5

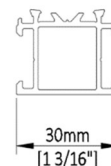



WPSFA0002 – SASH FRAME ASSEMBLY (SFA)

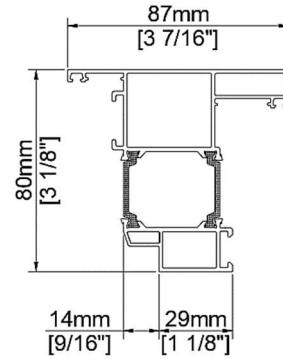

WPOSF0002 – OUTSIDE SASH FRAME (OSF)  
6063-T5

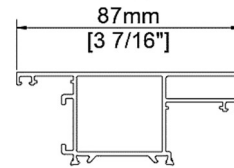

WPISF0002 – INSIDE SASH FRAME (ISF)  
6063-T5

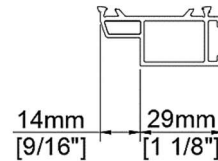

WPGSX0001 – GLASS STOP (GSX)  
6063-T5

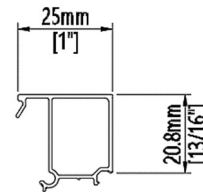

WPGSX0002 – GLASS STOP (GSX)  
6063-T5

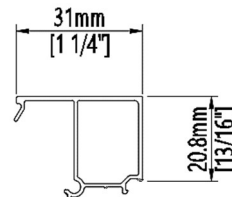





WPGSX0003 – GLASS STOP (GSX)  
6063-T5

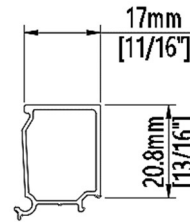

WPGSX0004 – GLASS STOP (GSX)  
6063-T5

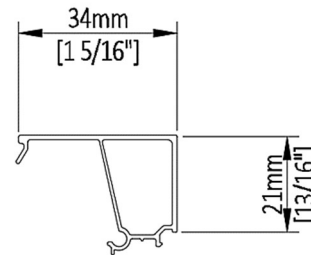

**GLAZING (INSULATED GLASS UNITS)**

Tempered, Low-E, Argon Filled, Warm-Edge Spacer, 3A Molecular Sieve

GITPA0001 - TRIPLE PANE ASSEMBLE (TPA)

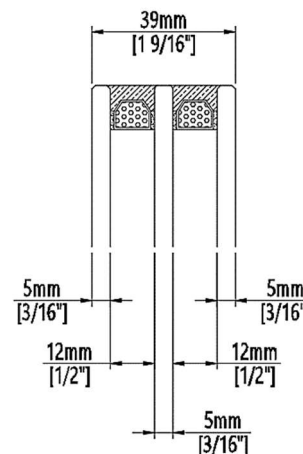



GIDPA0001 - DOUBLE PANE ASSEMBLY (DPA)

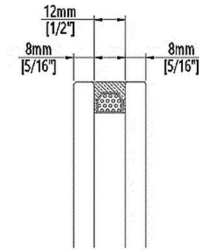

GIDPA0002 - DOUBLE PANE ASSEMBLY (DPA)

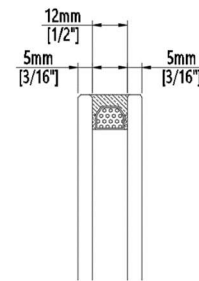

WAGSB0001 - GLASS SETTING BLOCK (GSB)  
PVC

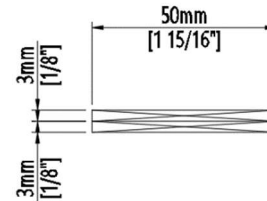

WAGSB0002 - GLASS SETTING BLOCK (GSB)  
PVC

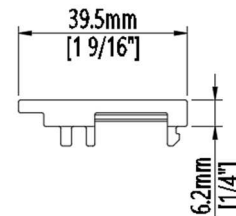

WAGSB0002 - GLASS CORNER SETTING BLOCK (CSB)  
PVC

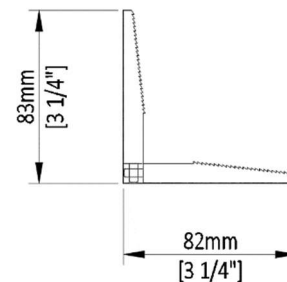



**SEALS**

EPDM rubber is a high-density synthetic rubber used for outdoor applications and other spaces in need of tough, versatile parts.

WSIGX0001 - INTERIOR GASKET (IGX)  
EPDM RUBBER

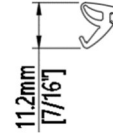

WSEGX0002 - EXTERIOR GASKET (EGX)  
EPDM RUBBER

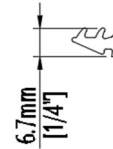

WSIGX0003 - INTERIOR GASKET (IGX)  
EPDM RUBBER

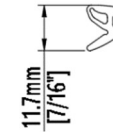

WSEGX0001 - EXTERIOR GASKET (EGX)  
EPDM RUBBER

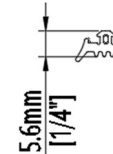

WSEGX0002 - EXTERIOR GASKET (EGX)  
EPDM RUBBER

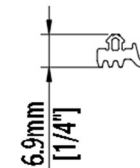

WSMFX0001 – MID-FRAME GASKET (MFG)  
EPDM RUBBER

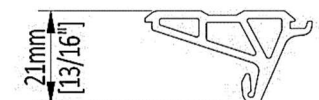



**OTHER COMPONENT/S**

WADXX0001 – EXTERIOR DRAIN COVER (DXX)  
PVC

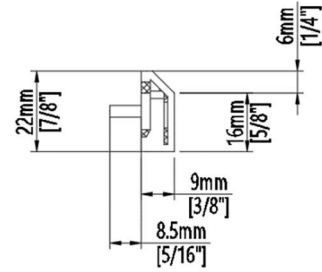

WAWBX0001 – WEATHER BAR (WBX)  
6063-T5

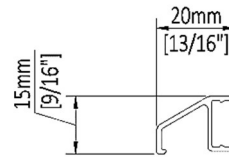

WPCKX0001 – CORNER JOINT KEY (CJK)  
STAINLESS STEEL

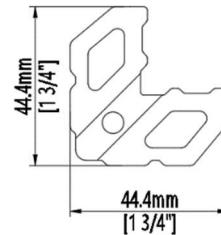

WPCJB0001 – CORNER JOINT BLOCK D-3/4" (CJB)  
6063-T5

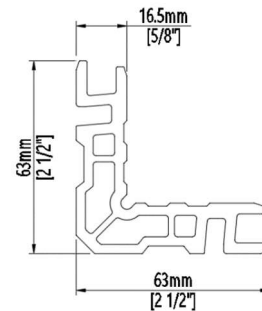

WPCJB0002 – CORNER JOINT BLOCK D-1/2" (CJB)  
6063-T5

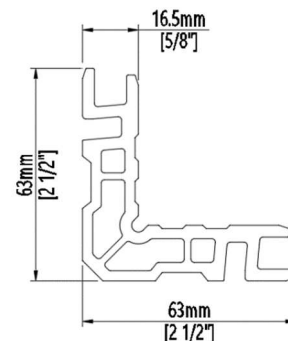



PFE6X0001 – PF EXTENDER (152:6)  
6063-T5

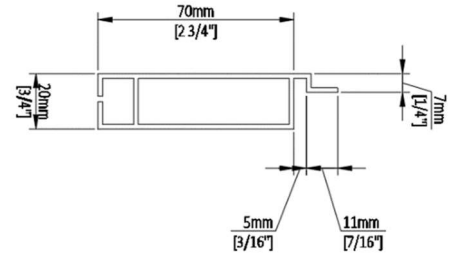

PFE8X0001 – PF EXTENDER (203:8)  
6063-T5

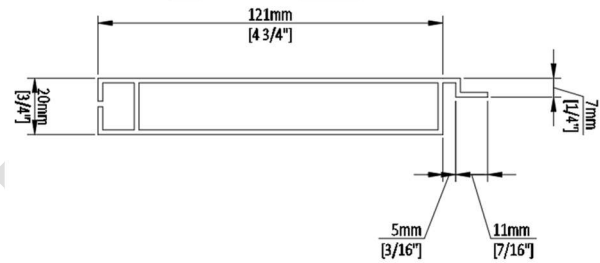

PFBMX0001 – PF BRICK MOULD  
6063-T5

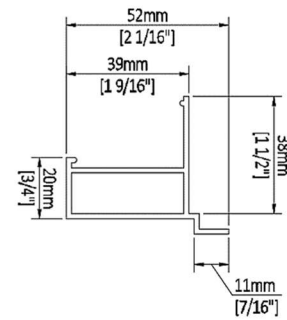

WFIFX0001 – INJECTED FOAM INSULATION (IFX)

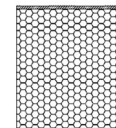



**ENERFREES**  
Window & Wall Systems

## AWNING WINDOW

## S-EF1070

### HARDWARE

E-HOC HANDLE

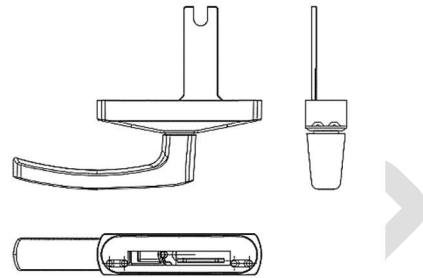

E-HEXTR HINGE 93:3-5/8

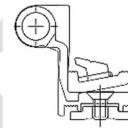

ENERFREES



---

**EF1070 AWNING WINDOW**

**GENERAL SPECIFICATION**

**I. PACKAGE INCLUDES**

Manufacturing includes labour, materials, and services for the complete fabrication and assembly of EF1070 fixed window system. Fabrication to include all necessary accessories and components, anchors, joint blocks, drain cover, seal rubbers, hardware, and sealants as required in the purchase agreement.

**II. PACKAGE EXCLUDES**

Structural installation or provision, framing, interior and exterior trims replacement/repairs, concrete masonry, brick restoration, final cleaning, protection, and/or any related work as specified.

**III. PERFORMANCE AND QUALITY STANDARD REQUIREMENT AND ASSURANCE**

Enerfree's EF1070 Fixed Window supplied to client under this specification must comply to the performance standard requirements and test report from an independent testing laboratory certifying compliance shall be given upon request by the owner/architect/contractor.

Test Required: AAMA/WDMA/CSA 101/I.S.2/A440-17 NAFS – North American Fenestration Standard / Specification for windows, doors and skylights and A440S1:19 Canadian Supplement to AAMA/WDMA/CSA 101/I.S.2/A440-17 NAFS - North American Fenestration Standard / Specification for windows, doors and skylights.

**IV. MANUFACTURING REFERENCES**

An approved shop drawing shall be provided for manufacturing reference and Enerfree's pricing. Enerfree's pricing and drawing shall be signed back to finalize manufacturing and fabricating details.

**V. ALUMINUM EXTRUSION**

All extruded aluminum sections shall be 6063-T5 alloy or equivalent.

**VI. FASTENERS**

Fasteners shall be stainless steel.

**VII. FABRICATION/MANUFACTURING**

Window will be fabricated according to the approved shop drawings. All joints will be assembled tight using manufactures provided assembly machines to comply with quality standard and assurance to carry out the product design performance.



VIII. INSTALLATION

Enerfree's products that will be installed shall conform with the manufacturer's instructions and should comply with approved shop drawings. The work shall be performed by qualified or certified installer using proper equipment to carry out necessary, proper, and efficient installation in a professional manner.

IX. PROTECTION

Exposed aluminum finished surface shall be protected from contamination of mortar, concrete, paint, mud, soil, grease, sealant or caulking compound, and any other harmful substance that can cause damage to surface finish from prolonged adhesion.

X. CLEANING

Provisional cleaning shall perform primary clear-out after installation and final cleaning shall be executed by the project owner in accordance with the general conditions listing methods outlined in AAMA 609 and 610-02.

**AWNING INTEGRATION TO FIXED WINDOW**

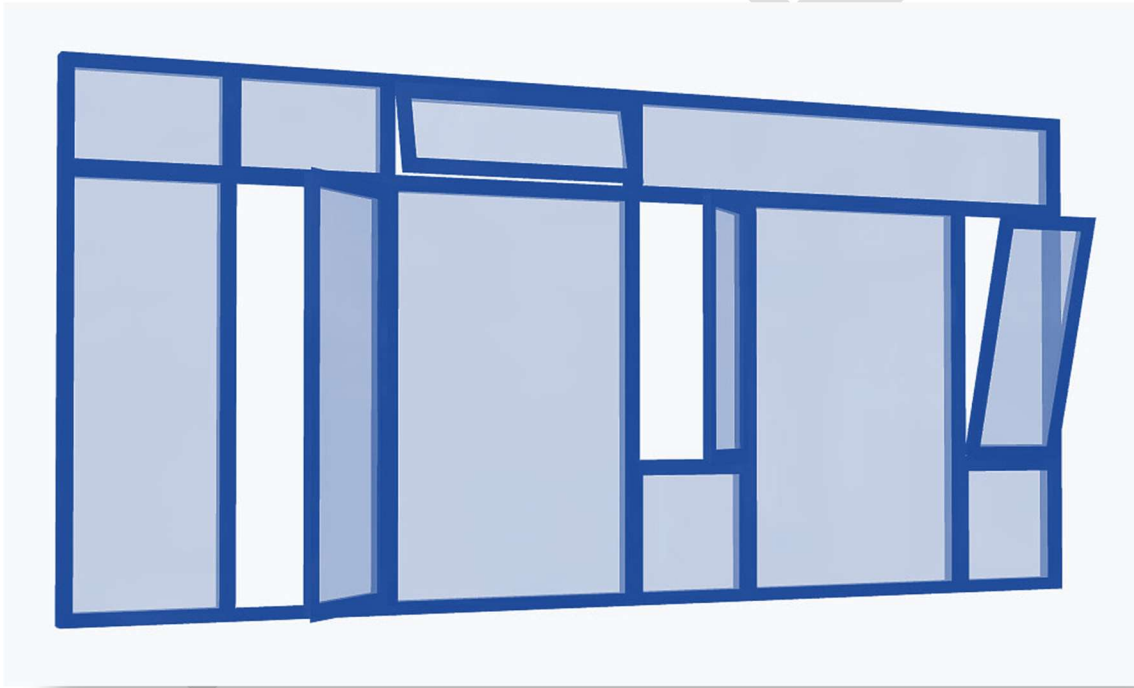

Enerfree's EAW-1070 is unlimited to integrate different operations and functionality to fixed window with custom sizes within the minimum/maximum width and height limits as specified.